

**Pieces / Pièces**

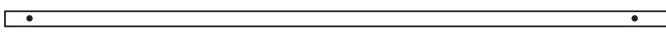
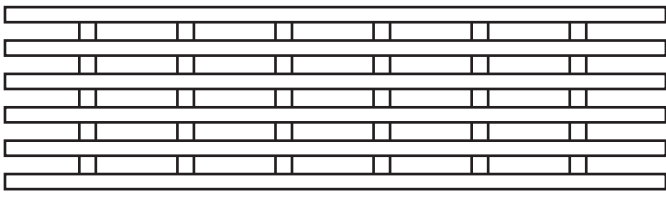
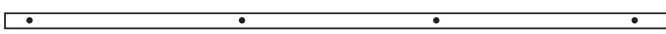
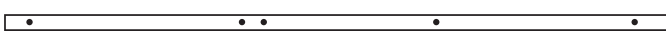

**A- 1x** 

**B- 4x** 

**C- 2x** 

**D- 2x** 

---

**S- 18x**  

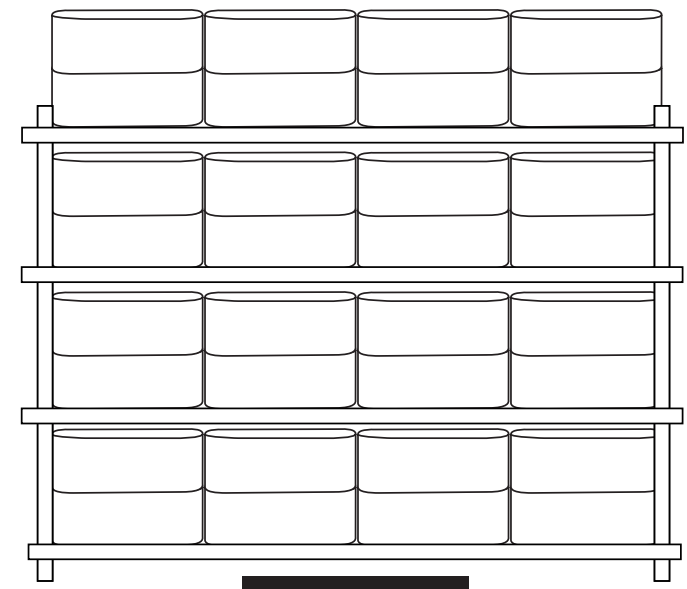

finished/fini

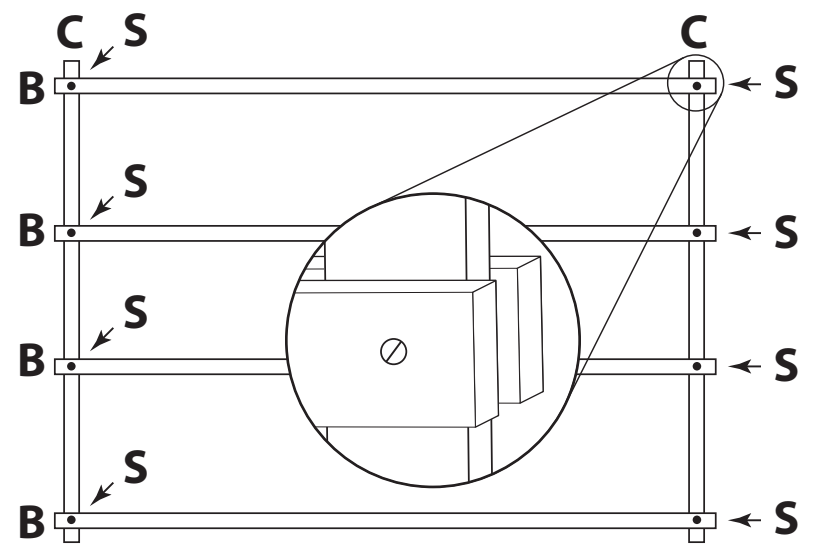

front-view / vue-de-face

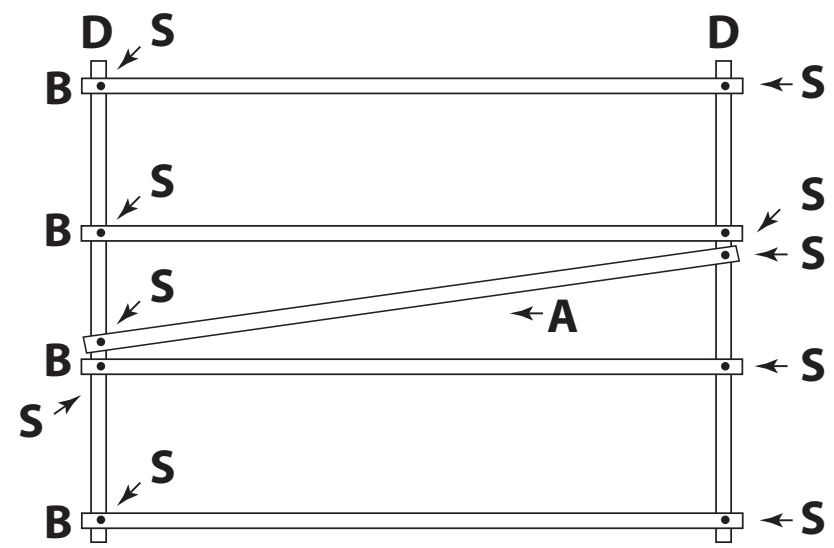

rear-view / vue-arrière